

---

**ROCIA**

ARM-MOUNTED | FLEXIBLE-TUBE | PIVOTING-HEAD LUMINAIRES





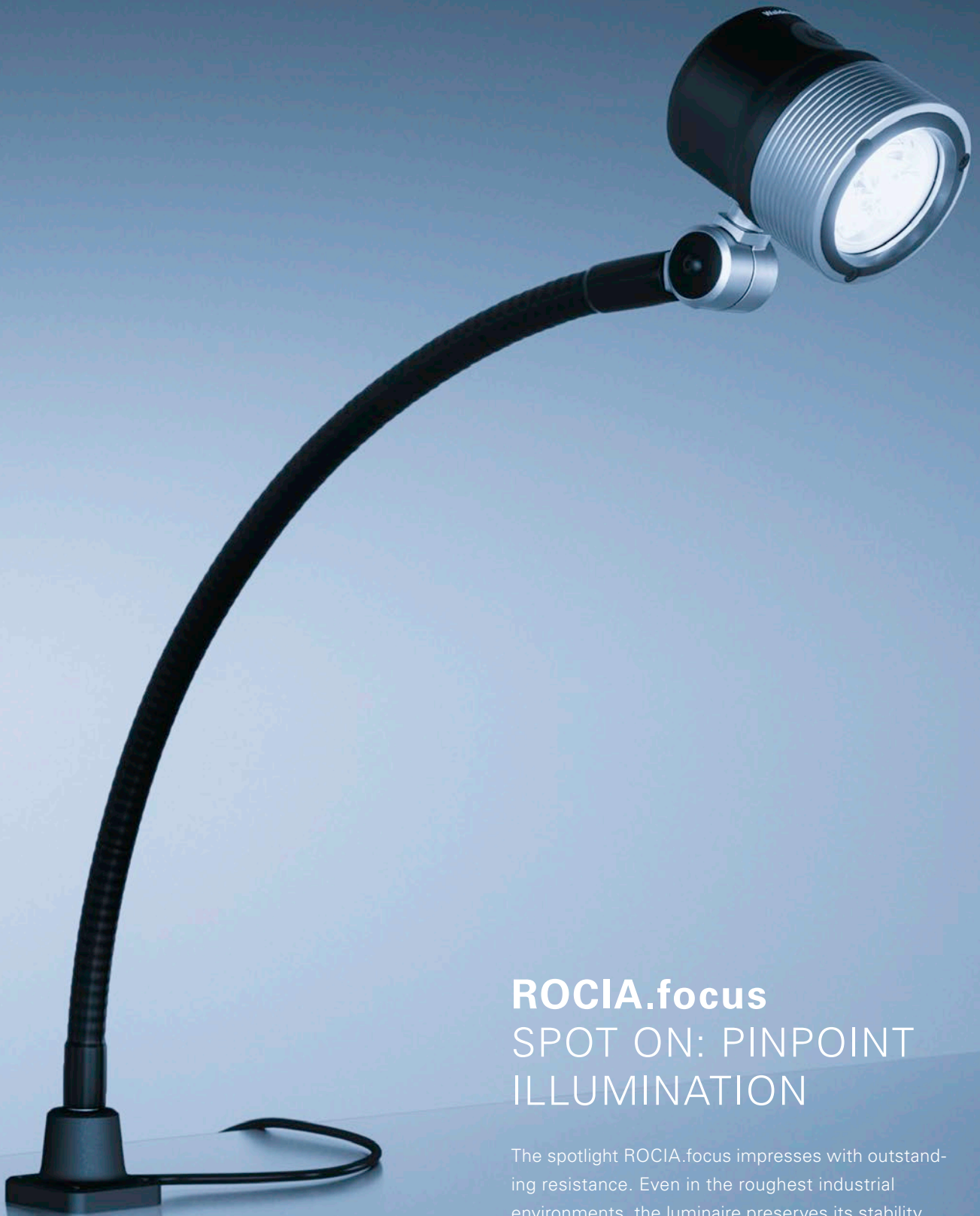

## **ROCIA.focus** SPOT ON: PINPOINT ILLUMINATION

The spotlight ROCIA.focus impresses with outstanding resistance. Even in the roughest industrial environments, the luminaire preserves its stability and ensures precise and pinpoint illumination. Exactly adjustable connections, optics with different beam angles and a flicker-free dimming allow an optimum control of the state-of-the-art high-power LEDs.



## **ROCIA.focus**

### PERFECT TECHNOLOGY – PRECISE LIGHT

- Maintenance-free LED technology with strong high-power LEDs
- Infinitely adjustable and flicker-free dimming
- Versions with narrow and wide angles of illumination
- Exactly adjustable arm-mounted, flexible-tube and pivoting-head luminaires
- Extremely resistant luminaire made of solid metal with impact resistant cover and a high degree of protection
- Connection to machine or mains voltage
- Integrated power supply unit and internal cable



#### **Exactly adjustable.**

Whether it is equipped with a double arm with spring-balanced base joint, a flexible tube with additional head joint or pivoting head with adjustable friction: The ROCIA.focus can be positioned with utmost precision. Considering the required degrees of freedom and the available mounting options, ROCIA.focus brings the light exactly where it is needed.

#### **Extra efficient.**

ROCIA.focus offers: beam angle of 10° or 40° for optimum adaptation to the environment and the visual task; exact coordination of optics and LEDs for illuminances of up to 30 000 lx despite the small size; switchable dimming function for flicker-free dimming down to 30 %. Even when not dimmed, ROCIA.focus saves, compared with the respective halogen luminaires, up to 90 % of energy. Thanks to the LED's long service life of at least 50 000 h, it is not necessary to replace the lamp!



#### **Extremely robust.**

The luminaire head and the arm made of aluminium, the flexible steel tube, the die-cast joints and the cables and seals made of particularly resistant materials give the ROCIA.focus a very long service life. The completely sealed housing prevents liquids, dust or foreign objects from entering into the luminaire and protects the electronic and electric systems from being damaged.

#### **Excellently connected.**

The wide-range electronics and the integrated rectifier of the ROCIA.focus offer a constant light output in a supply voltage range of 12 – 28 VAC or 12 – 40 VDC. Arm-mounted and flexible-tube luminaires are also available with integrated power supply unit so that they can operate directly and without wall power supply at 100 – 240 VAC.

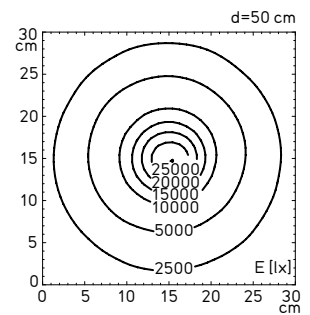
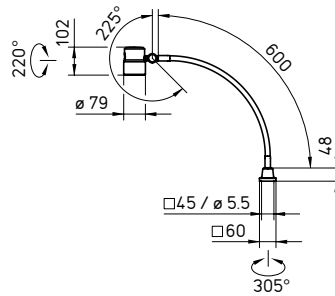
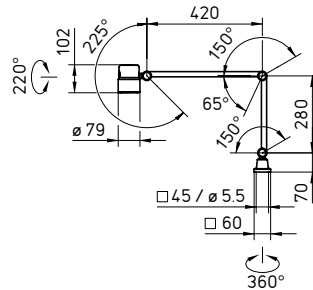

Illuminance with 10° optics

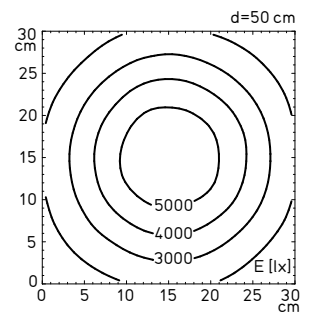
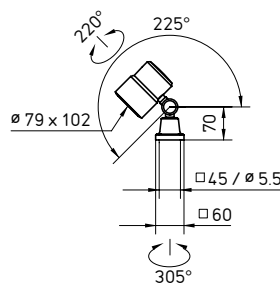



Illuminance with 40° optics



### ROCIA focus compact

- Colour temperature neutral white 5000 K
- Colour rendering  $R_a > 80$
- 10° or 40° angle of illumination
- Black and colourless anodised aluminium housing, 3 mm thick safety glass
- Partially spring-balanced arm, flexible tube or head joint
- With switch in the luminaire head (arm-mounted/flexible-tube luminaire) for switching and dimming or without switch (pivoting-head luminaire)
- Supply voltage 100 – 240 VAC (with transformer) or 12 – 28 VAC / 12 – 40 VDC (without transformer)
- Maximum permissible ambient temperature  $T_{a,max}$  up to 40 °C (without transformer)
- LED service life (L70) > 60000 h
- Degree of protection IP67; protection class I (with transformer) or III (without transformer)
- Supplied with approx. 3 m connecting line and grounded plug, type CEE 7/7 (with transformer) or free strand ends (without transformer)
- Different mounting elements as accessories



### Arm-mounted luminaires

 Machine tools		 Woodworking machines		 Textile machinery	
Fitted with Consumption	Operating device Connected load	Dimensions Special feature	$E_m$ $E_{max}^*$	Model Order No.	
LED	integrated	–	5088 lx <sup>1</sup>	RFD 600/850/D	
9.5 W	100 – 240 V, 50/60 Hz	10° optics, dimmable	30053 lx <sup>1</sup>	113 181 000 - 006 791 31	
LED	integrated	–	3255 lx <sup>1</sup>	RFD 600/850/D	
9.5 W	100 – 240 V, 50/60 Hz	40° optics, dimmable	5600 lx <sup>1</sup>	113 181 000 - 006 801 67	
LED	–	–	5088 lx <sup>1</sup>	RFD 600/850/DS	
8.5 W	12 – 28 VAC, 12 – 40 VDC	10° optics, dimmable	30053 lx <sup>1</sup>	113 182 000 - 006 801 10	
LED	–	–	3255 lx <sup>1</sup>	RFD 600/850/DS	
8.5 W	12 – 28 VAC, 12 – 40 VDC	40° optics, dimmable	5600 lx <sup>1</sup>	113 182 000 - 006 802 08	

### Flexible-tube luminaires

 Machine tools		 Woodworking machines		 Textile machinery	
Fitted with Consumption	Operating device Connected load	Dimensions Special feature	$E_m$ $E_{max}^*$	Model Order No.	
LED	integrated	–	5088 lx <sup>1</sup>	RFF 600/850/D	
9.5 W	100 – 240 V, 50/60 Hz	10° optics, dimmable	30053 lx <sup>1</sup>	113 183 000 - 006 689 96	
LED	integrated	–	3255 lx <sup>1</sup>	RFF 600/850/D	
9.5 W	100 – 240 V, 50/60 Hz	40° optics, dimmable	5600 lx <sup>1</sup>	113 183 000 - 006 802 51	
LED	–	–	5088 lx <sup>1</sup>	RFF 600/850/DS	
8.5 W	12 – 28 VAC, 12 – 40 VDC	10° optics, dimmable	30053 lx <sup>1</sup>	113 184 000 - 006 802 72	
LED	–	–	3255 lx <sup>1</sup>	RFF 600/850/DS	
8.5 W	12 – 28 VAC, 12 – 40 VDC	40° optics, dimmable	5600 lx <sup>1</sup>	113 184 000 - 006 802 85	

### Pivoting-head luminaires

 Machine tools		 Woodworking machines		 Textile machinery	
Fitted with Consumption	Operating device Connected load	Dimensions Special feature	$E_m$ $E_{max}^*$	Model Order No.	
LED	–	–	5088 lx <sup>1</sup>	RFJ 600/850/S	
8.5 W	12 – 28 VAC, 12 – 40 VDC	10° optics	30053 lx <sup>1</sup>	113 185 000 - 006 686 13	
LED	–	–	3255 lx <sup>1</sup>	RFJ 600/850/S	
8.5 W	12 – 28 VAC, 12 – 40 VDC	40° optics	5600 lx <sup>1</sup>	113 185 000 - 006 802 93	

\*  $E_m$  = medium illuminance;  $E_{max}$  = maximum illuminance; <sup>1</sup> Measuring field 30 cm x 30 cm/Measuring distance 50 cm

# ROCIA.planar

## LIGHT ALL OVER THE AREA

The wide-area luminaire ROCIA.planar convinces the practitioners by its solid metal design. The 3D head joint, the high illuminance and the outstanding light quality guarantee an exact adjustability and set standards regarding the ergonomics. Moreover, the efficient and maintenance-free LED technology reduces the operating costs and improves the environmental balance.





# ROCIA.planar

## TECHNOLOGY IN PERFECTION

- Maintenance-free LED technology with strong and homogeneous light
- Exactly adjustable arm with 3D head joint
- Extremely resistant luminaire made of solid metal with impact resistant cover and a high degree of protection
- Integrated power supply unit and internal cable for connection to mains voltage

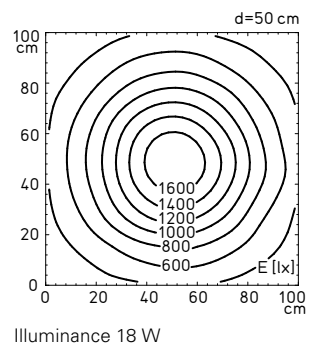
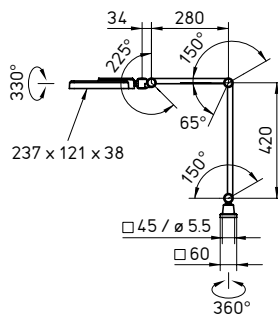

### ROCIA.planar compact

- Colour temperature neutral white 5000 K
- Colour rendering Ra >80
- Glare-free through opal white screen
- Black painted aluminium housing, plastic screen from PC
- Partially spring-balanced arm
- With switch in the light head
- Supply voltage 100 – 240 VAC
- LED service life (L70) > 60000 h
- Degree of protection IP67; protection class I
- Supplied with approx. 3 m connecting line and grounded plug, type CEE 7/7
- Different mounting elements as accessories

Machine tools		Woodworking machines		Textile machinery	
Fitted with	Operating device	Dimensions	E <sub>m</sub>	Model	
Consumption	Connected load	Special feature	E <sub>max</sub> *	Order No.	
LED	integrated	–	783 lx <sup>1</sup>	RPD 1700/850	
18 W	100 – 240 V, 50/60 Hz	–	1752 lx <sup>1</sup>	113 458 000 - 006 689 76	

\* E<sub>m</sub> = medium illuminance; E<sub>max</sub> = maximum illuminance; <sup>1</sup> Measuring field 100 cm x 100 cm/Measuring distance 50 cm

**HEADQUARTERS GERMANY**

Herbert Waldmann GmbH & Co. KG  
Postfach 50 62  
78057 VILLINGEN-SCHWENNINGEN  
GERMANY  
Telephone +49 7720 601 - 0  
Telephone +49 7720 601 - 100 (Sales)  
Fax +49 7720 601 - 290  
www.waldmann.com  
sales.germany@waldmann.com

**FRANCE**

Waldmann Eclairage S.A.S.  
Zone Industrielle  
Rue de l'Embranchement  
67116 REICHSSTETT  
FRANCE  
Telephone +33 3 88 20 95 88  
Fax +33 3 88 20 95 68  
www.waldmann.com  
info-fr@waldmann.com

**ITALY**

Waldmann Illuminotecnica S.r.l.  
Via della Pace, 18 A  
20098 SAN GIULIANO MILANESE (MI)  
ITALY  
Telephone +39 02 98 24 90 24  
Fax +39 02 98 24 63 78  
www.waldmann.com  
info-it@waldmann.com

**THE NETHERLANDS**

Waldmann B.V.  
Lingewei 19  
4004 LK TIEL  
THE NETHERLANDS  
Telephone +31 344 631019  
Fax +31 344 627856  
www.waldmann.com  
info-nl@waldmann.com

**AUSTRIA**

Waldmann Lichttechnik Ges.m.b.H.  
Gewerbepark Wagram 7  
4061 PASCHING/LINZ  
AUSTRIA  
Telephone +43 7229 67400  
Fax +43 7229 67444  
www.waldmann.com  
info-at@waldmann.com

**SWEDEN**

Waldmann Ljusteknik AB  
Skebokvarnsvägen 370  
124 50 BANDHAGEN  
SWEDEN  
Telephone +46 8 990 350  
Fax +46 8 991 609  
www.waldmann.com  
info-se@waldmann.com

**SWITZERLAND**

Waldmann Lichttechnik GmbH  
Benkenstrasse 57  
5024 KÜTTIGEN  
SWITZERLAND  
Telephone +41 62 839 1212  
Fax +41 62 839 1299  
www.waldmann.com  
info-ch@waldmann.com

**UNITED KINGDOM**

Waldmann Lighting Ltd.  
10 Millfield House  
Croxley Green Business Park  
WATFORD WD18 8YX  
UNITED KINGDOM  
Telephone +44 1923 800030  
Fax +44 1923 800016  
www.waldmann.com  
info-uk@waldmann.com

**USA**

Waldmann Lighting Company  
9 W. Century Drive  
WHEELING, ILLINOIS 60090  
USA  
Telephone +1 847 520 1060  
Fax +1 847 520 1730  
www.waldmannlighting.com  
waldmann@waldmannlighting.com

**CHINA**

Waldmann Lighting (Shanghai) Co., Ltd.  
Part A11a, No. Five Normative Workshop  
199 Changjian Road, Baoshan  
SHANGHAI, P.R.C. 200949  
CHINA  
Telephone +86 21 5169 1799  
Fax +86 21 3385 0032  
www.waldmann.com  
info-cn@waldmann.com

**SINGAPORE**

Waldmann Lighting Singapore Pte. Ltd.  
77A Neil Road  
SINGAPORE 088903  
SINGAPORE  
Telephone +65 6275 8300  
Fax +65 6275 8377  
www.waldmann.com  
sales-sg@waldmann.com

**INDIA**

Waldmann Lighting Pvt. Ltd.  
Plot No. 52  
Udyog Vihar  
Phase-VI, Sector-37  
GURGAON-122001, HARYANA  
INDIA  
Telephone +91 124 412 1600  
Fax +91 124 412 1611  
www.waldmann.com  
sales-in@waldmann.com